

THIS DRAWING MAY NOT BE USED FOR ANY PURPOSE OTHER THAN BY THE OWNER. THE DRAWING & DESIGN ARE PROPERTY OF ROTONICS MANUFACTURING, INC. ALL DIMENSIONS SHOWN ARE OUTSIDE PART DIMENSIONS IN INCHES, AND MAY VARY DUE TO MATERIAL SHRINKAGE. SPECIFICATIONS ARE SUBJECT TO CHANGE WITHOUT NOTICE. GALLONS AND WEIGHTS ARE APPROXIMATE ONLY.

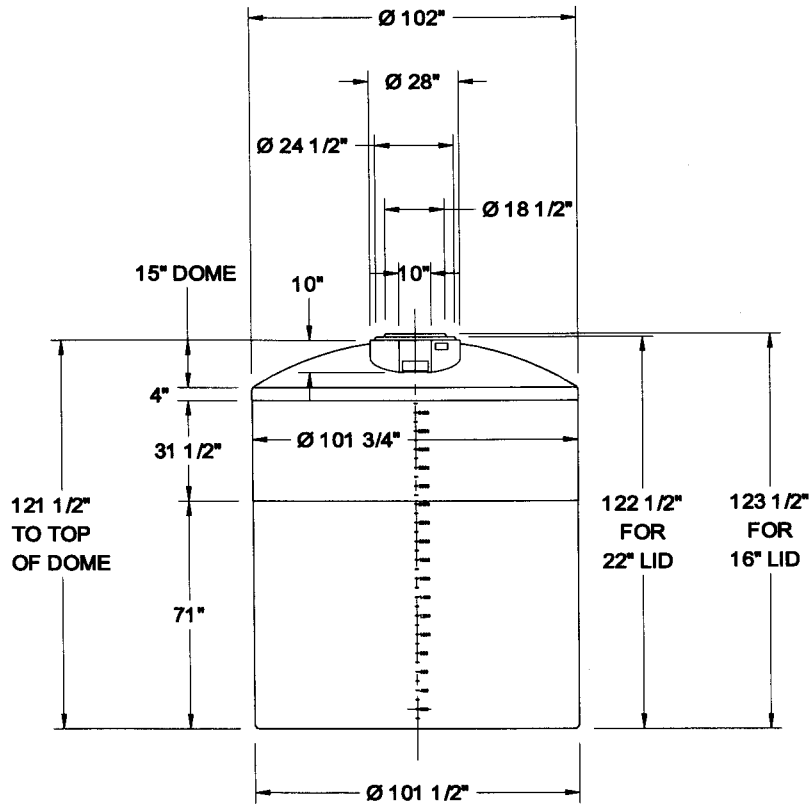

16" OR 22" THEADED LID

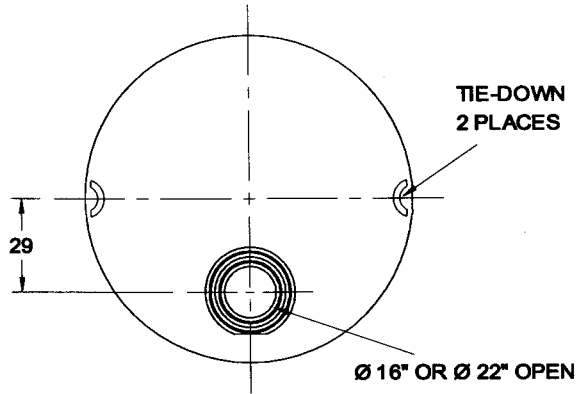
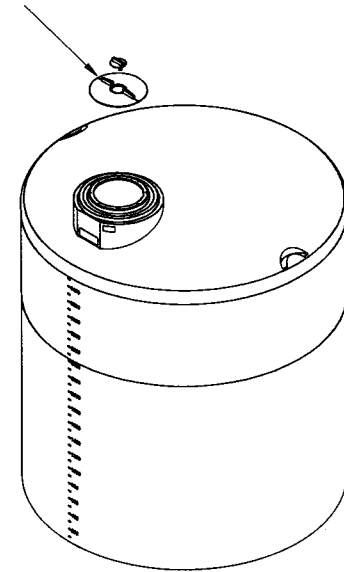

	OVERAL HEIGHT
WITH 16" LID	125 1/2"
WITH 22" LID	124 1/2"

RMI-I
716 No. 11th Avenue
Caldwell, Id 83605
Phone: 208-454-9271
Fax: 208-454-3089

RMI-G
17038 S. Figueroa St.
Gardena, CA 90248
Phone: 310-327-5401
Fax: 310-323-9567

DO NOT SCALE		ROTONICS MFG. INC.		
APPROVALS	DATE	#6406		
DRAWN BY: DPHAM	02/13/04	NEW Ø 102" - 4100 gal. VERTICAL TANK		
DESIGN BY: DPHAM		SIZE	DWG. No.	REV.
CHECKED BY: MARIO P.		A	S-1450	
APPROVED BY: MARIO P.		SCALE: 1 = 60		SHEET 1 of 1